

APPLICATIONS

- ✓ Relay Drives
- ✓ Motor (Start/Stop) Back EMF Protection
- ✓ Module Lightning Protection
- ✓ Secondary Lightning Protection for AC/DC

IEC COMPATIBILITY (EN61000-4)

- ✓ 61000-4-5 (Surge): 48A, 8/20 μ s - L3 (Line-Gnd), L4 (Line-Line) & L1 (Power)

FEATURES

- ✓ 15,000 Watts Peak Pulse Power per Line ($t_p=10/1000\mu$ s)
- ✓ Unidirectional & Bidirectional Configurations
- ✓ Easy Mounting to Printed Circuit Board
- ✓ Available in Multiple Voltage Types Ranging From: 17V to 220V
- ✓ RoHS Compliant

MECHANICAL CHARACTERISTICS

- ✓ Molded Case
- ✓ Weight 13 grams (Approximate)
- ✓ Available in Lead-Free Pure-Tin Plating(Annealed)
- ✓ Solder Reflow Temperature:
Pure-Tin - Sn, 100: 260-270°C
- ✓ Consult Factory for Leaded Device Availability
- ✓ Flammability Rating UL 94V-0
- ✓ Marking: Logo, Part Number & Date Code
- ✓ Positive Terminal Marked with Dot - *Unidirectional Only*

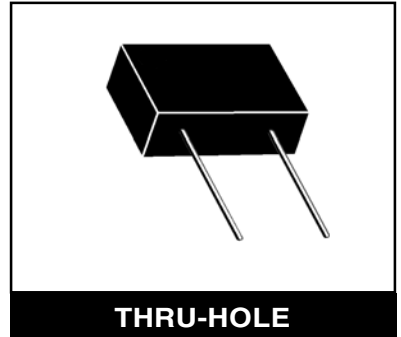
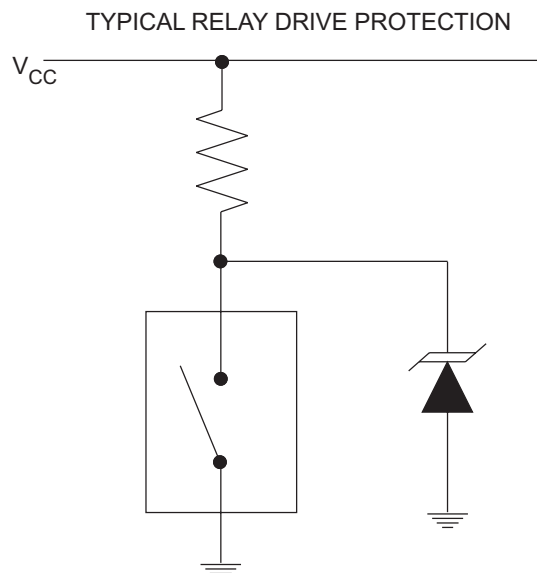
APPLICATION

15KP17A thru 15KP280A

DEVICE CHARACTERISTICS

MAXIMUM RATINGS @ 25°C Unless Otherwise Specified			
PARAMETER	SYMBOL	VALUE	UNITS
Peak Pulse Power (tp = 10/1000µs) - See Fig. 1	P _{PP}	15,000	Watts
Forward Surge Rating (1/20 seconds) - See Note 2	I _F	200	Amps
Steady State Power Dissipation	P _P	1.0	Watts
Storage Temperature	T _{STG}	-55 to 150	°C
Operating Temperature	T _L	-55 to 150	°C

ELECTRICAL CHARACTERISTICS PER LINE @ 25°C Unless Otherwise Specified						
PART NUMBER (Notes 1 & 2)	RATED STAND-OFF VOLTAGE V _{WM} VOLTS	BREAKDOWN VOLTAGE		MAXIMUM LEAKAGE CURRENT @ V _{WM} I _D µA	MAXIMUM CLAMPING VOLTAGE (See Fig. 2) @ 10/1000µs V _C @ I _{PP}	TEMPERATURE COEFFICIENT OF V _(BR) qV _(BR) mV/°C
		MIN V _(BR) VOLTS	@ I _T mA			
15KP17	17.0	18.9	50	5000	32.3V @ 464.0A	19
15KP17A	17.0	18.9	50	5000	29.3V @ 512.0A	17
15KP18	18.0	20.0	50	5000	34.2V @ 439.0A	20
15KP18A	18.0	20.0	50	5000	30.9V @ 485.0A	18
15KP20	20.0	22.2	20	1500	37.9V @ 396.0A	24
15KP20A	20.0	22.2	20	1500	34.3V @ 437.0A	21
15KP22	22.0	24.4	10	500	41.1V @ 365.0A	27
15KP22A	22.0	24.4	10	500	37.1V @ 404.0A	24
15KP24	24.0	26.7	5	150	45.0V @ 333.0A	30
15KP24A	24.0	26.7	5	150	40.7V @ 369.0A	27
15KP26	26.0	28.9	5	50	48.7V @ 308.0A	32
15KP26A	26.0	28.9	5	50	44.0V @ 341.0A	29
15KP28	28.0	31.1	5	25	52.4V @ 286.0A	35
15KP28A	28.0	31.1	5	25	47.5V @ 316.0A	31
15KP30	30.0	33.3	5	15	56.2V @ 267.0A	27
15KP30A	30.0	33.3	5	15	50.7V @ 296.0A	34
15KP33	33.0	36.7	5	10	60.6V @ 248.0A	42
15KP33A	33.0	36.7	5	10	54.8V @ 274.0A	38
15KP36	36.0	40.0	5	10	66.0V @ 227.0A	46
15KP36A	36.0	40.0	5	10	59.7V @ 251.0A	41
15KP40	40.0	44.4	5	10	72.8V @ 206.0A	51
15KP40A	40.0	44.4	5	10	65.8V @ 228.0A	46
15KP43	43.0	47.8	5	10	77.1V @ 195.0A	55
15KP43A	43.0	47.8	5	10	69.7V @ 215.0A	50
15KP45	45.0	50.0	5	10	80.7V @ 186.0A	57
15KP45A	45.0	50.0	5	10	73.0V @ 205.0A	52
15KP48	48.0	53.3	5	10	85.9V @ 175.0A	62
15KP48A	48.0	53.3	5	10	77.7V @ 193.0A	56
15KP51	51.0	56.7	5	10	91.5V @ 164.0A	66
15KP51A	51.0	56.7	5	10	82.8V @ 181.0A	60
15KP54	54.0	60.0	5	10	96.8V @ 155.0A	70
15KP54A	54.0	60.0	5	10	87.5V @ 171.0A	63
15KP58	58.0	64.4	5	10	104.0V @ 144.0A	76
15KP58A	58.0	64.4	5	10	94.0V @ 160.0A	68
15KP60	60.0	66.7	5	10	107.0V @ 140.0A	78
15KP60A	60.0	66.7	5	10	97.3V @ 154.0A	71
15KP64	64.0	71.1	5	10	115.0V @ 130.0A	84
15KP64A	64.0	71.1	5	10	104.0V @ 144.0A	76
15KP70	70.0	77.8	5	10	126.0V @ 119.0A	92
15KP70A	70.0	77.8	5	10	114.0V @ 132.0A	83

15KP17A thru 15KP280A

GRAPHS

ELECTRICAL CHARACTERISTICS PER LINE @ 25°C Unless Otherwise Specified

PART NUMBER (Notes 1 & 2)	RATED STAND-OFF VOLTAGE V_{WM} VOLTS	BREAKDOWN VOLTAGE		MAXIMUM LEAKAGE CURRENT $@V_{WM}$ I_D μA	MAXIMUM CLAMPING VOLTAGE (See Fig. 2) $@ 10/1000\mu s$ $V_C @ I_{PP}$	TEMPERATURE COEFFICIENT OF $V_{(BR)}$ $qV_{(BR)}$ $mV/^\circ C$
		MIN $V_{(BR)}$ VOLTS	$@I_T$ mA			
15KP75	75.0	83.3	5	10	135.0V @ 111.0A	100
15KP75A	75.0	83.3	5	10	122.0V @ 123.0A	89
15KP78	78.0	86.7	5	10	140.0V @ 107.0A	104
15KP78A	78.0	86.7	5	10	126.0V @ 119.0A	93
15KP85	85.0	94.4	5	10	152.0V @ 99.0A	113
15KP85A	85.0	94.4	5	10	137.0V @ 109.0A	102
15KP90	90.0	100.0	5	10	160.0V @ 94.0A	120
15KP90A	90.0	100.0	5	10	146.0V @ 103.0A	109
15KP100	100.0	111.0	5	10	179.0V @ 84.0A	134
15KP100A	100.0	111.0	5	10	162.0V @ 93.0A	121
15KP110	110.0	122.0	5	10	196.0V @ 77.0A	147
15KP110A	110.0	122.0	5	10	178.0V @ 84.0A	133
15KP120	120.0	133.0	5	10	214.0V @ 70.0A	161
15KP120A	120.0	133.0	5	10	193.0V @ 78.0A	145
15KP130	130.0	144.0	5	10	231.0V @ 65.0A	174
15KP130A	130.0	144.0	5	10	209.0V @ 72.0A	157
15KP150	150.0	167.0	5	10	268.0V @ 56.0A	202
15KP150A	150.0	167.0	5	10	243.0V @ 62.0A	183
15KP160	160.0	178.0	5	10	287.0V @ 52.0A	216
15KP160A	160.0	178.0	5	10	259.0V @ 58.0A	195
15KP170	170.0	189.0	5	10	304.0V @ 49.0A	229
15KP170A	170.0	189.0	5	10	275.0V @ 55.0A	207
15KP180	180.0	200.0	5	10	321.0V @ 47.0A	242
15KP180A	180.0	200.0	5	10	291.0V @ 52.0A	219
15KP200	200.0	222.0	5	10	356.0V @ 42.0A	269
15KP200A	200.0	222.0	5	10	322.0V @ 47.0A	243
15KP220	220.0	245.0	5	10	393.0V @ 38.0A	297
15KP220A	220.0	245.0	5	10	356.0V @ 42.0A	269
15KP240	240.0	267.0	5	10	428.0V @ 35.0A	324
15KP240A	240.0	267.0	5	10	388.0V @ 39.0A	293
15KP260	260.0	289.0	5	10	464.0V @ 32.0A	352
15KP260A	260.0	289.0	5	10	419.0V @ 36.0A	317
15KP280	280.0	311.0	5	10	500.0V @ 30.0A	378
15KP280A	280.0	311.0	5	10	452.0V @ 33.0A	342

Note 1: Part numbers shown are unidirectional devices. Add a "CA" suffix to specify bidirectional devices, such as 15KP20CA.

Note 2: $V_F = 7.5$ Volts @ 200A, 8.3ms (1/2 Sine Wave) - unidirectional devices only.

GRAPHS

FIGURE 1
PEAK PULSE POWER VS PULSE TIME

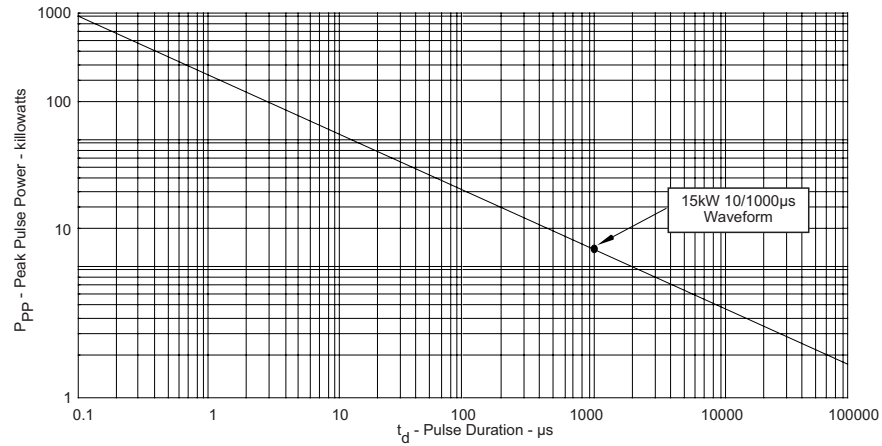

FIGURE 2
PULSE WAVE FORM

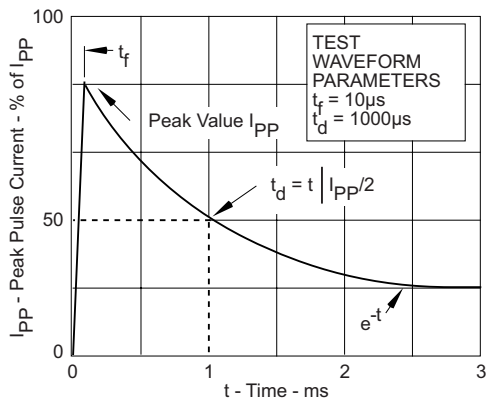
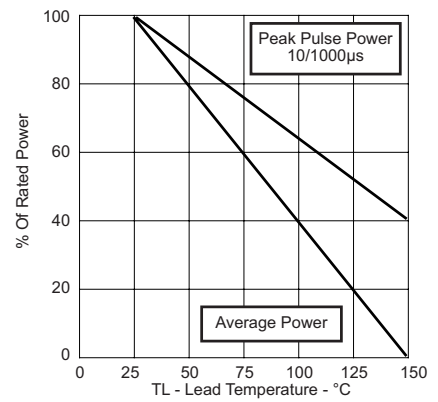

FIGURE 3
POWER DERATING CURVE



15KP17A thru 15KP280A

THRU-HOLE PACKAGE OUTLINE & DIMENSIONS

PACKAGE OUTLINE

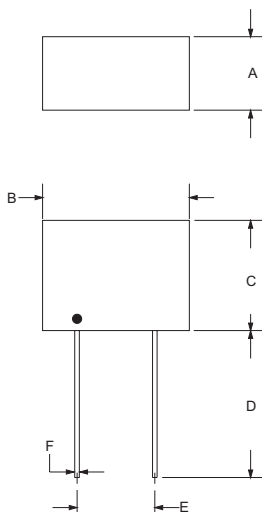

THRU-HOLE

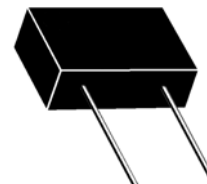

PACKAGE DIMENSIONS

DIM	MILLIMETERS		INCHES	
	MIN	MAX	MIN	MAX
A	9.18	11.22	0.36	0.44
B	24.38	26.42	0.96	1.04
C	15.75	17.27	0.62	0.68
D	16.51	-	0.65	-
E	14.74	15.75	0.58	0.62
F	1.19	1.35	0.047	0.053

NOTES

1. Dimensions are exclusive of mold flash and metal burrs.

Outline & Dimensions: Rev 1 - 7/02, 06027

COPYRIGHT © ProTek Devices 2007

SPECIFICATIONS: ProTek reserves the right to change the electrical and or mechanical characteristics described herein without notice (except JEDEC).

DESIGN CHANGES: ProTek reserves the right to discontinue product lines without notice, and that the final judgement concerning selection and specifications is the buyer's and that in furnishing engineering and technical assistance, ProTek assumes no responsibility with respect to the selection or specifications of such products.

ProTek Devices

2929 South Fair Lane, Tempe, AZ 85282

Tel: 602-431-8101 Fax: 602-431-2288

E-Mail: sales@protekdevices.com

Web Site: www.protekdevices.com